

Welcome

LPWAN and Wi-SUN FAN 1.1 Rollout

Vikram Pochampally – Sr. Field Application Engineer

tech talks



LPWAN

Agenda

8 May 2024

- **Introduction to LPWAN**
- **Omdia LPWAN Research**
 - Selecting the right LPWAN
 - Security
 - Support
- **Emerging LPWAN Applications**
 - Smart City Evolution
 - Building and Logistics Management
 - Smart Agriculture
- **Wi-SUN FAN1.1 Rollout**
 - FAN 1.1 Low Energy and High Performance
 - Supported Hardware and Software Tools
 - Certification
- **Summary**

What is LPWAN and What applications are served by LPWANs

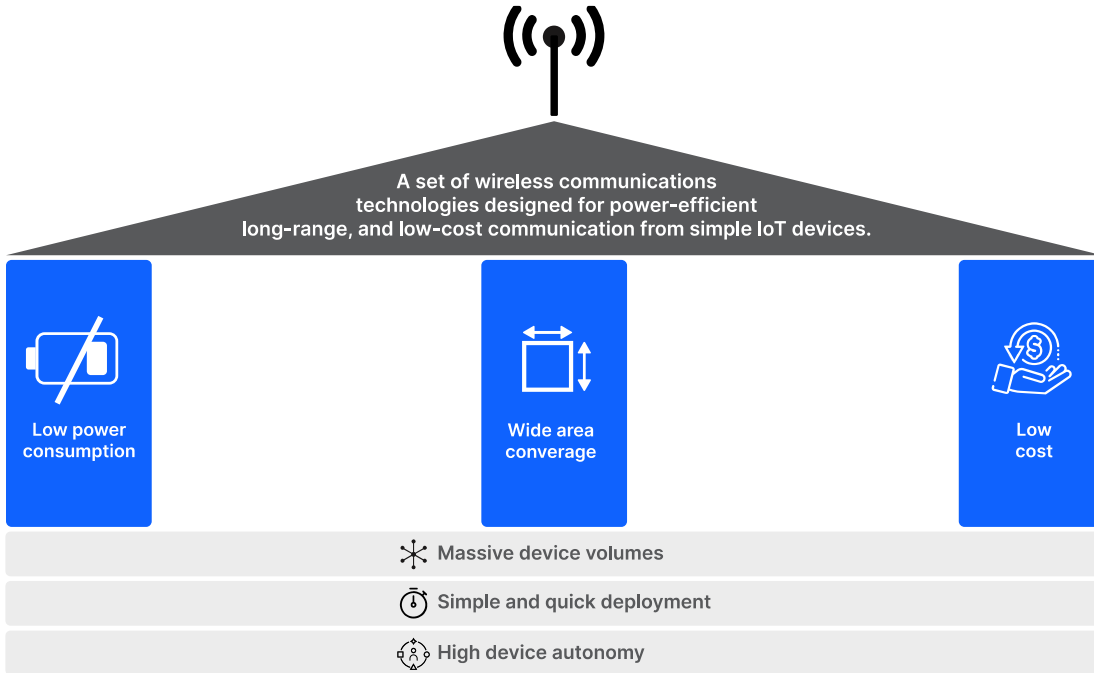

Definition

Low-power wide-area networks (LPWANs or LPWA networks) are a set of wireless communication technologies designed for power-efficient, long-range, and low-cost communication from simple IoT devices.

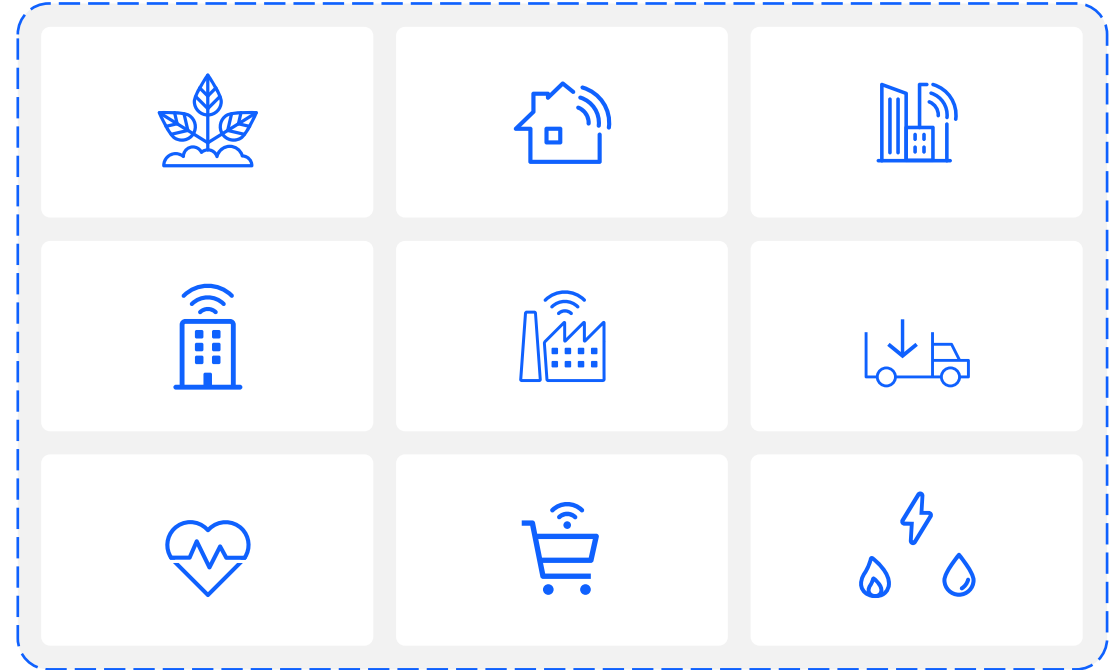

LPWAN Applications

IoT applications that are often cost-sensitive and characterized by infrequent transmissions of small bursts of data, many devices often spread over wide areas, and the need for devices to operate autonomously for many years.

LPWAN Positioning

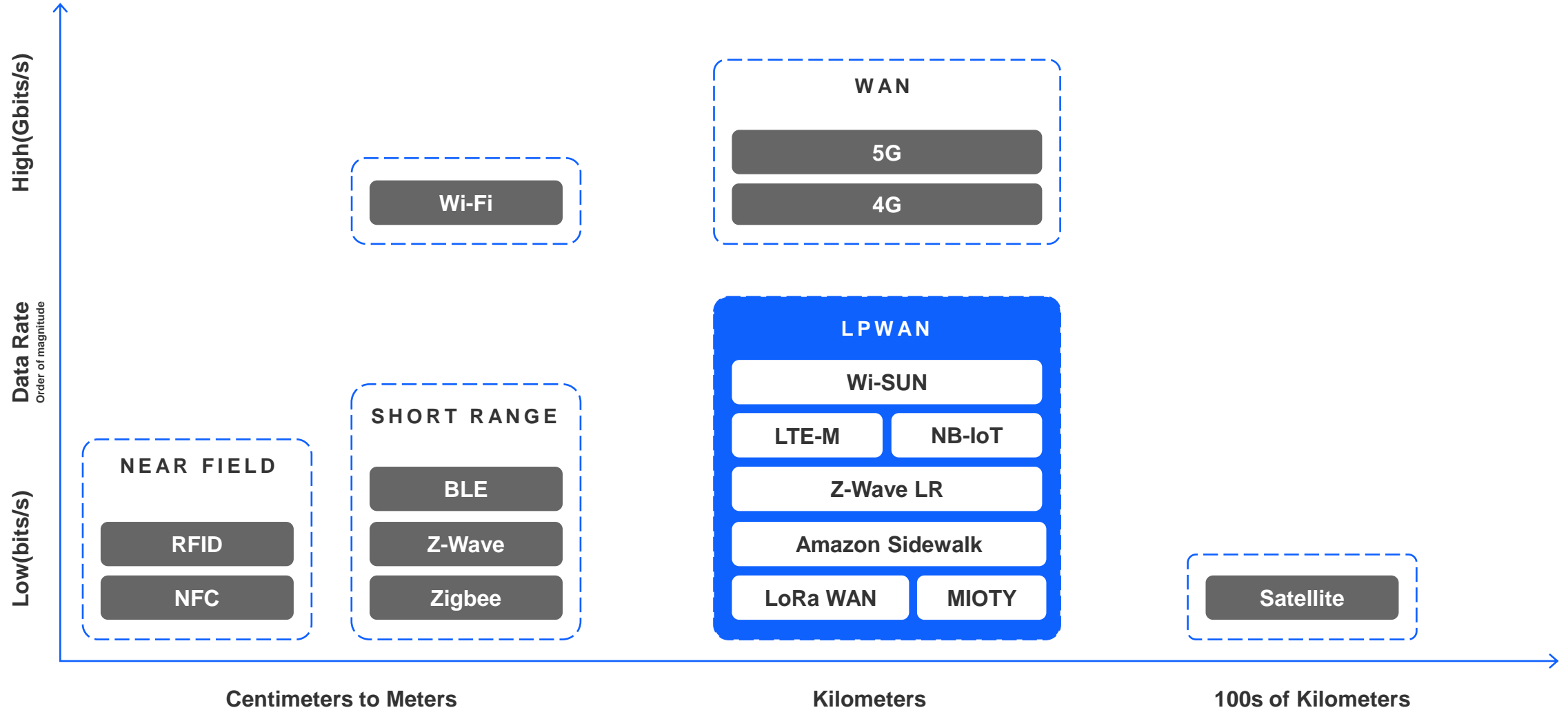

ANALYST SURVEY

Emerging LPWAN Connectivity Protocols: Attitudes and Advantages

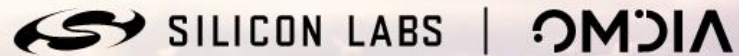

- **Silicon Labs coordinated with Omdia in 2023 for an LPWAN research report**
 - Globally focused with samples taken across multiple application areas
- **Focused on topics that are critical to LPWAN selection**
 - Networks being used
 - Roadblocks in deployment
 - Key considerations
- **Three main take aways:**
 - Picking right network is biggest concern of developers
 - Security continues to be a concern across region and application
 - Developer support is key consideration when selecting protocol and platform

How do you select the right LPWAN?

amazon sidewalk



WI SUN



WHICH ECOSYSTEM YOU WANT TO PARTICIPATE?



WHAT ARE YOUR APPLICATION REQUIREMENTS?

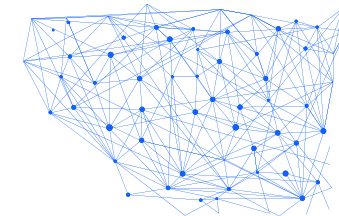
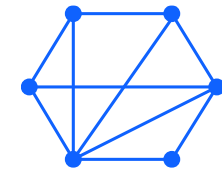
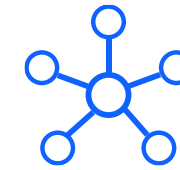

WHAT ARE YOUR NETWORK REQUIREMENTS?

There is no silver bullet. Selection comes down to ecosystem, application, network and several other factors

Standards Based vs Proprietary

Standards-Based LPWAN Solutions

- **Examples: Wi-SUN, MIOTY, Z-Wave, Cellular, LoRaWAN**
- **Typically governed by alliances or member groups**
 - Interest in the growth of the solution and ensuring needs of key applications or markets are met
- **Ensure multi-vendor interoperability**
 - Typically done through certification programs
- **Great for large scale networks that need to serve many different applications**
 - Establish connectivity backbone and provide platform for expansion
- **Not always optimized for all applications**
 - Compromises need to be made for interoperability or other overriding concerns

Proprietary LPWAN Solutions

- **Example: Wirepas, Amazon Sidewalk**
- **Usually managed and supported by a single entity**
 - May require licensing fee to get support and deploy
- **Typically optimized for single use case**
 - May have different stacks to support different applications
- **Interoperability limited depending on owner / developer of the protocol**
 - Can decided to keep things completely private or to open network to approved third parties
- **Can provide elevated levels of security**
 - Key network parameters can be kept private in order to maintain network and device level security

Growing needs for interoperability



- **Higher cost equipment is building out backbone of municipal LPWAN networks**
 - Streetlights, electric meters, and other line powered devices make up majority of existing LPWAN use cases
- **Allows for faster ROI for entities responsible for deployment of networks**
 - Looking to expand use cases and allow other devices on formerly private networks
 - Allows for service fee model to help recoup costs by allowing third party devices on networks
- **Enabling expansion of LPWAN connectivity into lower cost and low power nodes**
 - Gas meters, water meters, and environmental sensors are most frequently brought up first
- **Multi-vendor interoperability is critical to this growth**
 - Network accessibility and reliability are now being added at SLA level to guarantee performance

Interoperability Models

Standards-Based LPWAN Solutions

- **Interoperability is greatly simplified**
 - Standard compliance ensures network level interoperability
 - Application-level interoperability typically left up to developers
- **Certification process typically defines standard level of interoperability**
 - All solutions must function together at a minimum acceptable level
- **Can be changed as applications and standard evolves**
 - Changes can affect backward compatibility
- **Examples:**
 - Wi-SUN
 - Has standard certification process including certified test bed units for checks of stack and application
 - Ensures backward compatibility across versions of standard
 - Cellular
 - Spectrum licensed by carriers who manage interoperability
 - Typically, older versions are sunset as newer versions emerge leading to potential orphaning of devices

Proprietary LPWAN Solutions

- **Interoperability can be limited depending on proprietary solution**
 - Some take “walled garden” approach only allowing single manufacturer networks while others work to ensure multi-vendor compatibility
- **Certification can be network dependent**
 - Networks like Amazon Sidewalk have very strict certification process while others may not have any
- **Examples:**
 - Wirepas
 - Stack ownership by Wirepas ensures compatibility between devices
 - Amazon Sidewalk
 - Has very strict interoperability and certification program in place to ensure network “just works”
 - Homegrown Standard
 - Can limit interoperability by design and be optimized for very specific applications or use models
 - Interoperability dependent on inclusion of partners into ecosystem

EFR32: Flexible Platform for LPWAN Applications

- **Chipset selection is crucial for protocol flexibility and future proofing**
 - Ability to select protocol at program or run time creates design flexibility
- **Multi-protocol use cases growing throughout IoT world**
 - Need to exist in multiple ecosystems or to create differentiated user experiences
- **Growing need for development simplification**
 - Multiple code and footprint compatible options for Sub-GHz and 2.4GHz protocols
- **Common AI/ML and Security Subsystems simplify overall application development**
 - Can have leverage common algorithms or security schemes for reuse across product portfolio



Supported Protocols and Modulations

		xG22	xG23	FG25	xG28
Supported Protocols	Amazon Sidewalk		✓ (FSK Only)		✓ (Bluetooth LE and FSK)
	Wi-SUN			✓	✓ (FSK Only)
	Proprietary	✓	✓	✓	✓
	Wireless M-BUS		✓		✓
	Bluetooth	✓			✓
	Wirepas		✓		
	Mioty		✓		✓
	Z-Wave		✓		✓
	CONNECT	✓	✓	✓	✓
Supported Modulations	MR-OFDM			✓	
	(DSSS)-OQPSK	✓	✓		✓
	(G)MSK	✓	✓	✓	✓
	2/4(G)FSK	✓	✓	✓	✓
	OOK/ASK		✓		✓
	MR-OQPSK			✓	

Evolving Security Landscape



- **Emergence of multi-vendor and mission critical applications is increasing visibility in LPWAN security**
 - Expansion of networks and inclusion of third parties raises potential security risks
- **Sub-GHz spectrum has some security advantages**
 - Network exploitation tools are not as readily available as they are for more prevalent technologies
- **Different network solutions take different approaches to solve the security issue**
 - Wi-SUN
 - ▶ Inclusion of standard IEEE 802.15.4 security along with certificate-based authentication
 - Amazon Sidewalk
 - ▶ Very robust security built into network with public / private encryption used from device transmission to decryption at end destination
 - Wirepas
 - ▶ Security at the heart of stack with the inclusion of secure device provisioning, network level security, and secure OTA
 - Proprietary
 - ▶ Truly proprietary networks can have security advantages due to private nature

Support Models



- **Support models are different depending on network and chipset selection**
 - Structure can vary greatly from vendor to vendor or even within single vendor
 - Finding the best support model for you can be critical to the success of your development
- **Tools play a major part in overall support model**
 - Look for tools that simplify network evaluation and troubleshooting
 - Make sure you understand what is going to help simplify your overall development process
- **Code compatibility is critical to design success**
 - Allows you to focus on your application development and carry across multiple protocols and IC platforms

Integrated Support vs Combined Support

Integrated Support

- **All aspects of IC and wireless design supported by chipset supplier**
 - Creates single path of support for any design challenges or issues
- **Creates tighter relationship between designer and support team**
 - Allows for deeper knowledge share between partners
- **Silicon Labs Example: Wi-SUN**
 - Silicon Labs provides stack, wireless SoC, and all design support
 - Complete hardware and software reference designs for multiple node types and platforms
 - Certified stack and PHYs along with certified test bed unit simplifies end device certification process

Combined Support

- **Support typically provided by both wireless stack provider and SoC supplier**
 - Wireless SoC supplier supports SoC and hardware design
 - Software and stack support provided by stack supplier
- **Relationship between stack provider and SoC supplier can be critical to success of engagement**
 - Lack of familiarity can create unnecessary complications or roadblocks for developers
- **Silicon Labs Example: Wirepas**
 - Wirepas provides customers with SDK that includes support for Silicon Labs devices
 - Silicon Labs works with developers for hardware or SoC specific issues
 - Silicon Labs and Wirepas work to ensure reliability of Wirepas SDK and stack combination

LPWAN Applications

Smart City LPWAN Progression

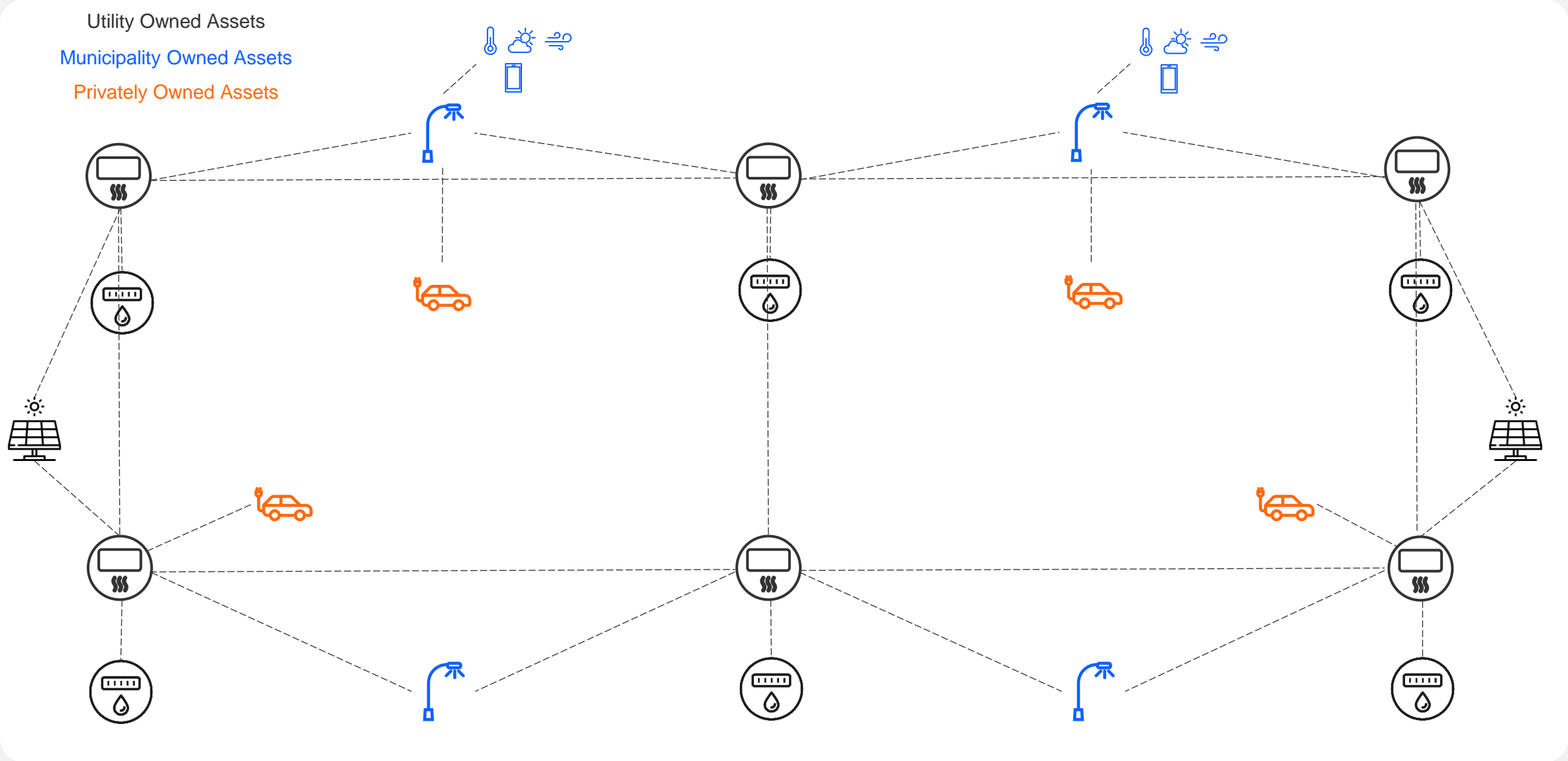

Recommended Smart City Protocols

	Wi-SUN	Wirepas	Mioty	Proprietary
Architecture:	Centralized Routing Mesh	Distributed Mesh	Star only	User selected
Support Model:	Integrated	Combined (Wirepas)	Combined (Fraunhofer IIS)	Integrated
Security:	IEEE 802.15.4 + Certificates	Secure Provisioning Secure OTA	AES-128 for data protection and integrity check, bulk/per-device basis provisioning	User selected
Supported EFR Families:	FG25 (FSK + OFDM), FG28(FSK)	FG13, FG23	FG23, FGM230S, FG28*	xG22, FG23, FG25, xG28
Value Proposition:	Alliance Governed	Small memory footprint	Very small memory footprint	Can be very application specific
	Backward Compatible	Sub-GHz and 2.4GHz support	Alliance Governed	High levels of security due to proprietary nature
	High throughput and low power use case support	Distributed mesh for simplified network infrastructure	Scalable and resilient to other sub-GHz communication	Multiple topology options
	Robust certification program	Great support for high density networks	Low data rate, low power, long range (deep indoor/hard to reach) applications	
	Network level interoperability	Low latency	Low network TCO	

Logistics / Warehouse Management

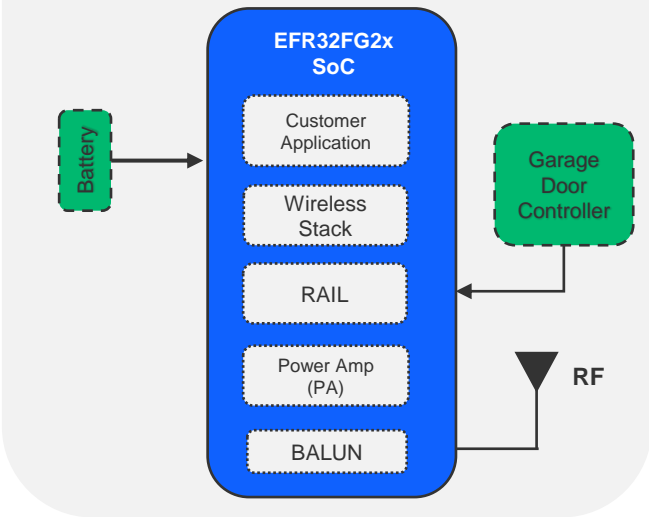

DESIGN CONSIDERATIONS

- Robust Connectivity to meet SLA requirements
- Environmental Conditions
- Security
- Total System Cost
- Long Range
- Scalability

HARDWARE SOLUTIONS

- **xG23**
 - Superior RF Performance (Link budget of ~146 dB)
 - Lower cost BOM with integrated DC/DC power supply, PA and BALUN
 - Low power consumption via Preamble Sense Mode, LESENSE
 - Can operate temperatures up to +125 °C
 - Secure Vault™ (certified PSA Level 3)
- **xG28**
 - High GPIO count (49)
 - Superior RF Performance (Link budget of ~146 dB)
 - AI/ML Accelerator for battery power consumption
 - Suitable for Wi-SUN battery-powered LFN nodes
 - Dual band support (Sub-GHz, 2.4GHz BLE)

RECOMMENDED PROTOCOLS

- **Wi-SUN**
 - Low Energy Nodes added with FAN 1.1
 - Network Backbone provided by line powered devices
- **Amazon Sidewalk**
 - Easy to deploy and scale
 - Low maintenance cost
- **Wirepas**
 - High node density
 - Distributed mesh architecture limits gateway needs

SOFTWARE SOLUTIONS

- **Wi-SUN (FG28)**
 - Certified stack
 - Certified PHYs¹
 - Complete integration into GSDK
 - Reference designs for all node types
- **Amazon Sidewalk**
 - Completely integrated Amazon Sidewalk SDK into GSDK
 - Optimized out of box experience for quick time to market
- **Wirepas**
 - Close relationship with Wirepas and proven reliability
 - Support on multiple wireless SoC platforms

1 – FG28 PHY certification scheduled to be completed in 23Q4

Legacy Wire Replacement



DESIGN CONSIDERATIONS

- Robust Connectivity to meet SLA requirements
- High Throughput
- Security
- Total System Cost
- Scalability

HARDWARE SOLUTIONS

- **FG25**
 - Superior RF Performance (Link budget of ~146 dB)
 - Lower cost BOM with integrated DC/DC power supply, PA and BALUN
 - Higher throughput with OFDM MCS7 support
 - Can operate temperatures up to +125 °C
 - Secure Vault™ (certified PSA Level 3)

RECOMMENDED PROTOCOLS

- **Proprietary**
 - Leverage standard PHYs for higher throughput
 - Close control over ecosystem to maintain IP and security

SOFTWARE SOLUTIONS

- **Proprietary**
 - Support for complete PHY and protocol customization with CONNECT stack or RAIL implementations
 - Radio configurator and network analyzer tools to simplify network development and analysis
- **Silicon Labs CONNECT**
 - Simplified way to develop proprietary networks
 - Point to point, star and extended star configurations available
 - 15.4 based MAC layer in MAC mode
 - Lightweight and flexible stack up to the network layer

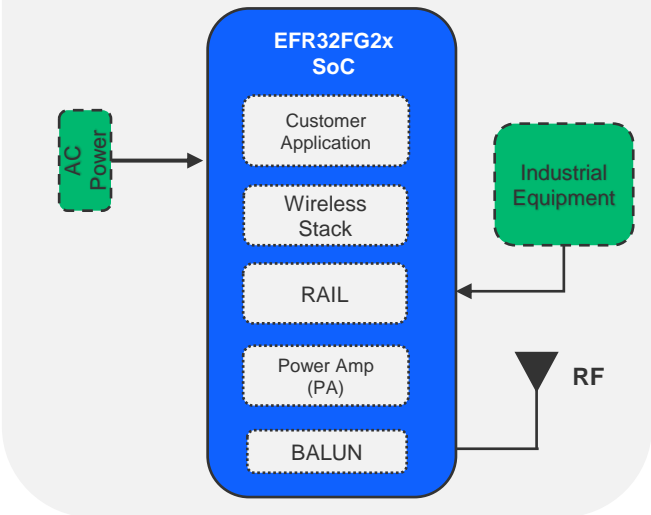

1 – FG28 PHY certification scheduled to be completed in 23Q4

Smart Irrigation and Soil Monitoring

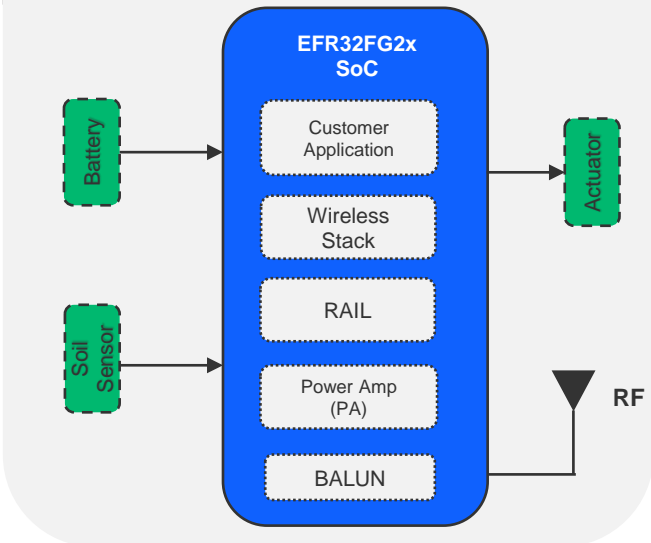

DESIGN CONSIDERATIONS

- Range
- Real time monitoring
- Battery Life
- AI / ML at the edge
- Environmental conditions
- Security

HARDWARE SOLUTIONS

- **FG23 / FGM230S**
 - Superior RF Performance (Link budget of ~146 dB)
 - Lower cost BOM with integrated DC/DC power supply, PA and BALUN
 - Output power options to +20 dBm
 - Small form factor SiP module for 868 and 915MHz bands
- **FG28**
 - High GPIO count (49)
 - Superior RF Performance (Link budget of ~146 dB)
 - AI/ML Accelerator for battery power consumption
 - Suitable for Wi-SUN battery-powered LFN nodes
 - Dual band support (Sub-G, 2.4G BLE)

RECOMMENDED PROTOCOLS

- **Wi-SUN**
 - Self forming / Self healing mesh topology
 - Interoperability for integration of multiple systems
- **Mioty**
 - Very long point to point range
 - Low power modes to greatly extend battery life
- **Z-Wave Long Range**
 - Very long point to point range
 - Proven deployed ecosystem

SOFTWARE SOLUTIONS

- **Wi-SUN (FG28)**
 - Certified stack
 - Certified PHYs
 - Integration into GSDK
 - Reference designs for all node types
- **Z-Wave (ZG28)**
 - Simplified development process with integrated SDKs
 - Certified SoCs and Modules
- **Mioty (FG23/FGM230S)**
 - Support for multiple device classes and communication profiles
 - Close partnership with Fraunhofer IIS for optimized combined support model

Summary



- **LPWAN implementations are changing**
 - Market is seeing some key use cases moving from proprietary to standards-based solutions
 - Formerly closed ecosystems are opening to allow for inclusions of multiple vendors and expanded applications
- **No silver bullet LPWAN solution**
 - No LPWAN option can address all needs of the market today
 - Must make compromises depending on ecosystem, application, and network requirements
- **Chipset platform is critical to ensuring product flexibility**
 - Platforms with protocol flexibility can minimize risk to product success
 - Code reuse lowers overall product development burden and creates simplicity

Q&A



LPWAN

Wi-SUN FAN 1.1 Rollout

Vikram Pochampally – Sr. Field Application Engineer

Wi-SUN FAN 1.0 Review



- **Wi-SUN Network Topology: Routing Mesh**
 - More like a tree than true mesh
 - All nodes are routing nodes and are always active
 - Border router maintains routing tables and ensures network backhaul
- **Primary Applications:**
 - Smart Cities
 - Smart Metering
 - Infrastructure
 - Energy Distribution
- **3 Types of Network Messages**
 - Unicast
 - From one node to another, communication flowing through neighbors
 - Routing with RPL (Routing Protocol for Low-Power and Lossy Networks)
 - Broadcast
 - Messages transmitted to all nodes within the range
 - Propagated with MPL (Multicast Protocol for Low-Power and Lossy Networks)
 - Asynchronous messages
 - Messages transmitted to all nodes within the range
 - Mainly used for network discovery and configuration (PAN Advert, PAN config, ...)
- **PHYs**
 - A single PHY is used for all messages (base PHY), i.e. all nodes talking the same language
 - Selection between 50, 100, 150, 200 & 300 kbps FSK
 - The PHY is selected upon the higher distance (range) between nodes and regional regulation
 - Frequency hopping is used

Wi-SUN Communication Summary and frequency hopping

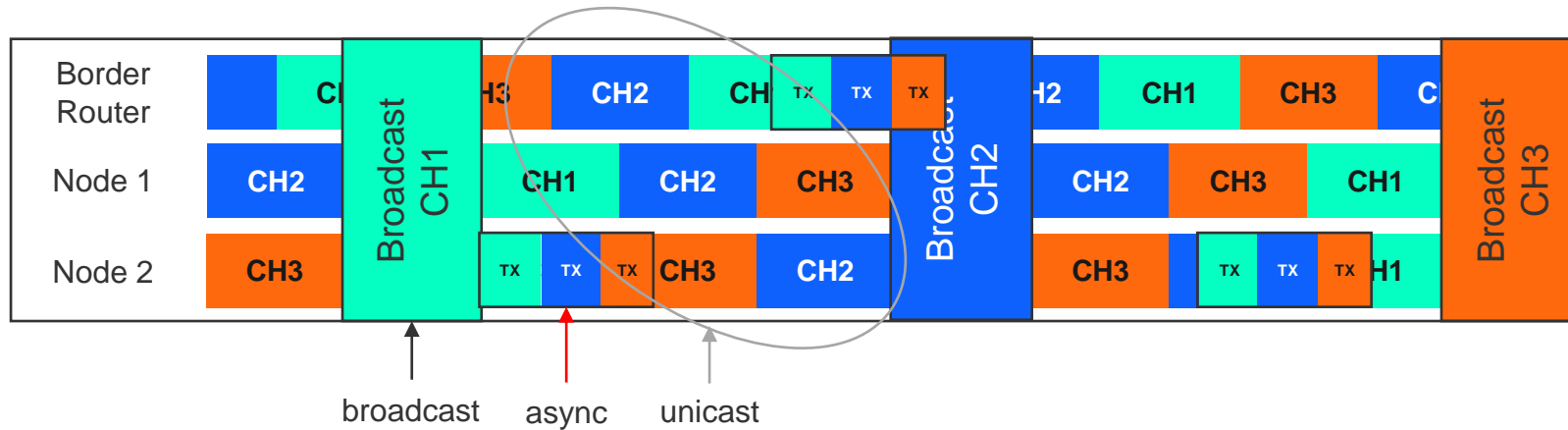

▪ Broadcast

- Has priority over Unicast
- All nodes switch to broadcast channel to listen

▪ Asynchronous

- Has priority over Unicast and Broadcast
- Transmits on all channels

▪ Unicast

- Impacted by broadcast and asynchronous traffic
- The transmitter adapts to receiver node channel

=> Configuration is key to adapt the Wi-SUN stack and its performance to the application.

What is FAN 1.1?



- **FAN 1.1 is an extension of FAN 1.0 to address higher bit rates and low power nodes**
 - Keeps the basis of FAN 1.0
- **Indeed, these new topics are optional in FAN 1.1 specification, so we get 3 pieces:**
 - 1. FAN 1.1 Core (aka FAN 1.0+)**
 - Only one feature added: PAN-wide Information Element
 - 2. FAN 1.1 High Performance option (HP)**
 - Introduces SUN-OFDM PHYs
 - Introduces mode switch
 - 3. FAN 1.1 Low Energy option (LE)**
 - Introduces Limited Function Nodes (LFN)

FAN 1.1 Low Energy: Limited Function Nodes (LFN)



- LFN allows **battery powered applications** as nodes are sleeping most of the time
- The typical use case is a node transmitting **1-2 kB per day**
 - The goal is to reach a lifetime of 20 years with a typical LiMnO₂ 3.x volt / 2 AH battery
- These nodes **cannot be routers, so this is limited to leaf nodes**
 - Routers are referred to as Full Function Nodes (FFN)
- The “LFN parenting” feature is required on a router to allow support of LFN children
 - The FFN parent is managing LFN Broadcast and Unicast schedules
 - The FFN parent is buffering the message to be delivered to the LFN
- LFN is available for
 - EFR32FG28 (FSK only)
 - EFR32FG25 (FSK & OFDM)

Limited Function Nodes (LFN): some figures

Schedules

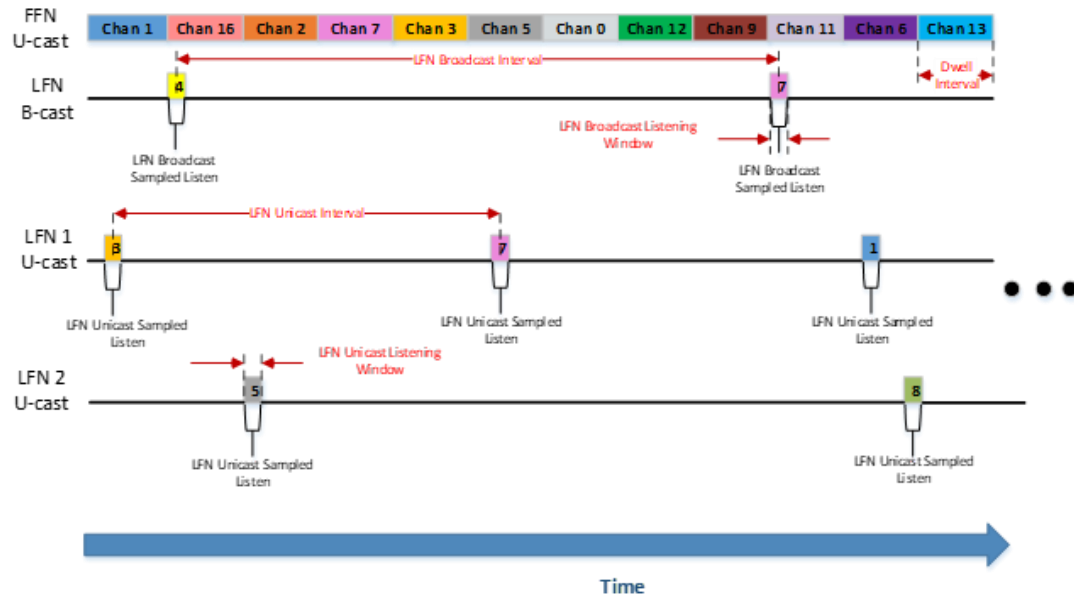

Specific schedules for LFN Unicast and LFN broadcast on top of usual (FFN) schedules

- LFN broadcast interval: from 10 sec to 10 minutes
- LFN Unicast interval: 30 sec to ... 4 h

=> Network to be configured to tradeoff latency and consumption

Power Consumption

Conditions:

- Balanced configuration
 - ▶ LFN Unicast interval: 60 sec
 - ▶ LFN Broadcast Interval: 5 minutes
- Traffic scenario
 - ▶ 50kbps FSK
 - ▶ Transmission of a 100 B packet every 8 hours
 - ▶ Wake up for unicast and broadcast listening windows

=> Average consumption 1.5 μ A on top of EM2, i.e. 6 μ A total for EFR32FG28

=> Leads to >30 years lifetime for a 2000mAh battery

xG28: Single or Dual Band SoC for the Next Generation of IoT



Single or Dual Band
More GPIOs

DEVICE SPECIFICATIONS

High Performance Dual Band Radio

- Up to +20 dBm Sub-GHz Output Power
- -125.8 dBm Rx Sensitivity @ 915 MHz 4.8 kbps O-QPSK
- Up to +10 dBm 2.4 GHz Output Power
- -94.2 dBm Rx Sensitivity @ BLE 1 Mbps

Efficient ARM® Cortex®-M33

- Up to 78 MHz
- Up to 1024kB Flash, 256kB RAM

Low Power

- 82.8 mA TX Current (915 MHz, +20 dBm)
- 26.2 mA Tx Current (915 MHz, +14 dBm)
- 4.6 mA RX (915 MHz 4.8 kbps O-QPSK)
- 22.5 mA TX Current (2.4 GHz +10 dBm)
- 5.2 mA RX (BLE 1 Mbps)
- Active Current: 33 µA/MHz @39 MHz
- 1.3 µA EM2 (16 kB Retained) / 2.8 µA EM2 (256 kB Retained)

Protocol support

- Wi-SUN
- Amazon Sidewalk
- CONNECT
- Wireless M-BUS
- Proprietary
- Bluetooth LE

Package Options

- 6x6 QFN48 (31 GPIO)
- 8x8 QFN68 (49 GPIO)

DIFFERENTIATED FEATURES

Single and Dual Band Support

- Supports Sub-GHz and Sub-GHz + Bluetooth LE

Large memory footprint

- Support larger stacks or applications in a single chip

AI/ML accelerator

- Faster inferencing with lower power

Secure Vault™ Mid and High options

- Flexible platform for evolving security needs

Support for Wi-SUN Mode Switch

- Support for use of multiple FSK PHYs in a single network

16-bit ADC

- Up to 14-bit ENOB for better analog resolution

Preamble Sense

- Ultra low power receive mode

Antenna Diversity

- 6-8 dBm better link budget (Sub-GHz only)

Segment LCD

- 4x48 segment LCD

High GPIO count

- Support up to 49 GPIO

FAN 1.1 High Performance: OFDM

- OFDM brings

- High bit rates, up to 2.4 Mbps
 - 3.6 Mbps w/ EFR32FG25 additional mode
- Intrinsic flexibility on bit rates and performance levels
 - Sometimes referred to as MR-OFDM (multi-rate)
 - Packet-by-packet flexibility, within the same bandwidth
 - Each option has 7 Modulation and Coding Schemes
 - MCS0 (low bit rate) to MCS6, in-packet signaling

- High bit rates bring

- Higher throughputs which are helpful for OTA
- Shorter burst duration leading to
 - Better latency
 - Improved network performance & less congestion

bandwidth (KHz)	modulation	bit rate (kbps)	Tx duration (ms)
200	FSK 1b	50	241.92
	FSK 2a	100	120.96
	OFDM 4 MCS6	300	41.52
400	FSK 3	150	80.85333333
	FSK 4a	200	60.64
	OFDM 3 MCS6	600	21.48
600	FSK 5	300	40.74666667
800	OFDM 2 MCS6	1200	11.52
1200	OFDM 1 MCS6	2400	6.12

Example for 1500-Byte frame

OFDM high bit rates

OFDM option	Bandwidth (kHz)	Main regions	Bit rates (kbps)	Sensitivity (dBm)
1	1200	NA, BZ	100 to 2400 (3600*)	-111 to -95
2	800	NA, BZ, JP	50 to 1200 (1800*)	-113 to -98
3	400	NA, BZ, JP	25 to 600 (900*)	-115 to -101
4	200	NA, BZ, JP, EU	12.5 to 300 (450*)	-116 to -104

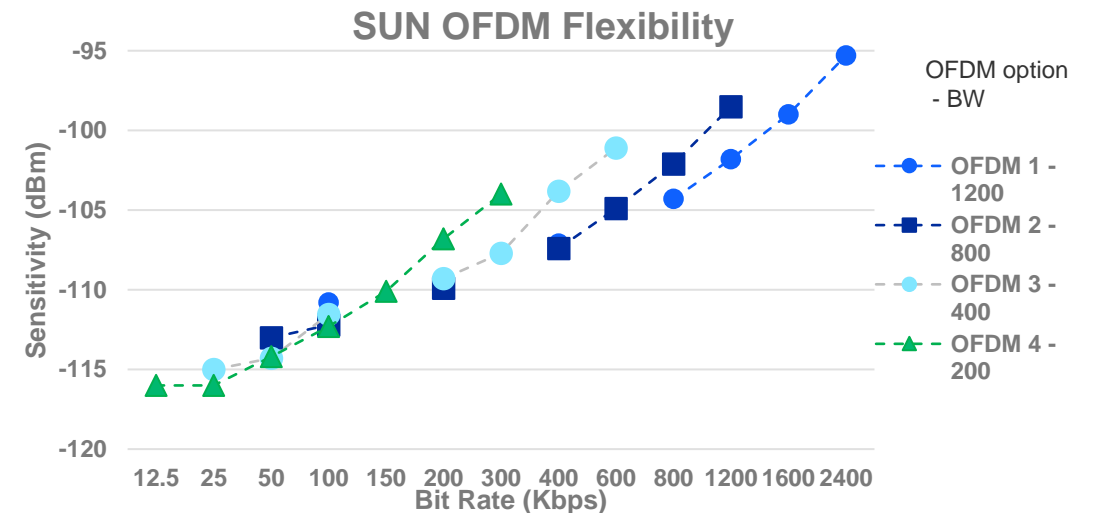

OFDM Performance compared to FSK: Europe – India case

- Europe, India mainly use 200 kHz channel spacing

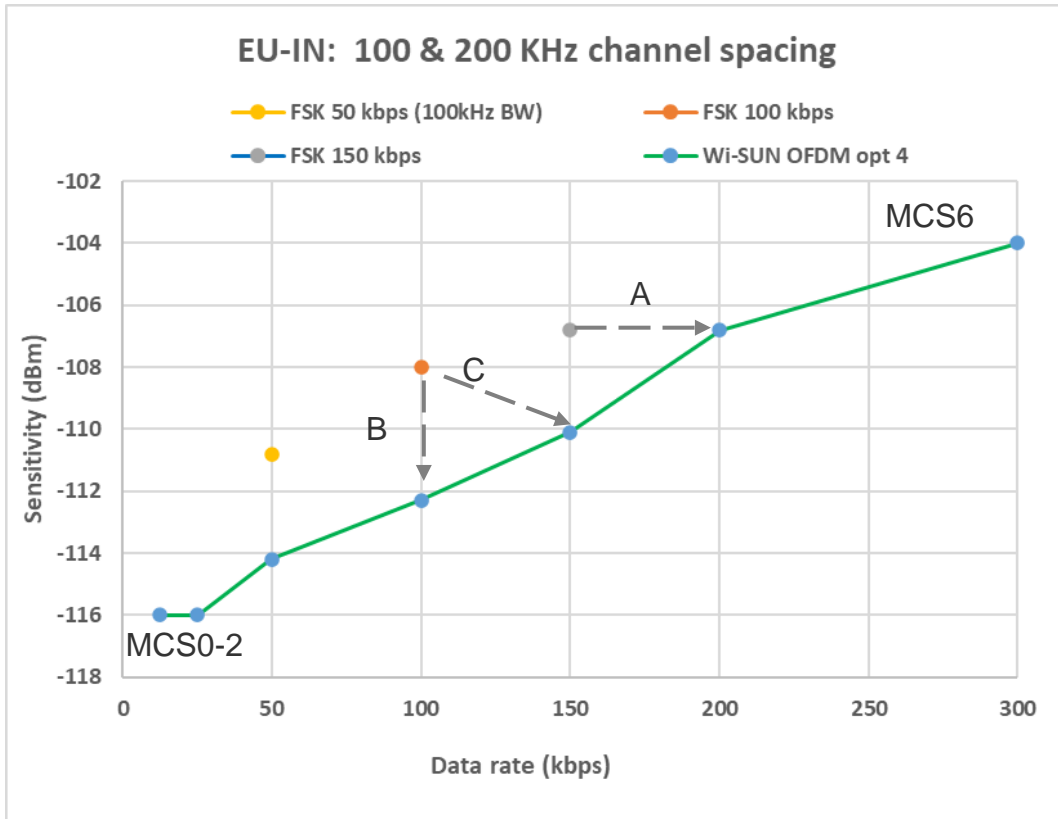

- **OFDM advantage vs FSK:**

- A: increased bit rate for same range
 - +30 to 50%
 - + 200% from FSK 50kbps (100 KHz BW)
- B: improved range for same bit rate
 - About 4 dB better sensitivity
- C: can be a combination of both
 - +50% and 2 dB

- **Note: same comparison applies for other countries**

- Europe & India are selected as the single channel bandwidth makes the comparison more fair

- **Intrinsic flexibility of OFDM allows**

- To use low MCS to increase range
- To use high MCS to increase throughput when conditions allow it

FG25: Optimized Solution for Smart Cities



Advanced MCU
Low Latency

DEVICE SPECIFICATIONS

High Performance Radio

- Up to +16 dBm Output Power
- -125.8 dBm Rx Sensitivity@ 915 MHz 4.8kbps O-QPSK
- -95.3 dBm Rx Sensitivity@ 914 MHz 2.4 Mbps Wi-SUN OFDM Option 1, MCS6

Efficient ARM® Cortex®-M33

- Up to 97.5 MHz
- Up to 1920kB Flash, 512kB RAM

Low Power

- 186 mA Tx Current (914 MHz +16 dBm)
- 6.3 mA Rx Current (924 MHz 400kbps 4-GFSK)
- Active Current: 30 μ A/MHz
- 4.6 μ A EM2 (512 kB Retained) / 2.6 μ A EM2 (32 kB Retained)

Protocol support

- Wi-SUN FAN 1.1
- Proprietary
- CONNECT

Package Options

- 7x7 QFN56 (37 GPIO)

DIFFERENTIATED FEATURES

Advanced Radio Functionality

- Supports OFDM and up to 3.6 Mbps data rates
- Concurrent Detection of OFDM and FSK

Robust Security

- Secure Vault™ Mid and High options for evolving security needs

16-bit ADC

- Up to 14-bit ENOB for better analog resolution

Mode Switch

- Allows for coexistence of FSK and OFDM nodes on a single network

Large Memory Footprint

- Up to 1920kB Flash, 512kB RAM

More GPIO

- Up to 37 GPIOs for better system integration

FAN 1.1 High Performance – Mode Switch

- **Entire Wi-SUN network uses single base PHY**
 - Defined by border router for Broadcast, Unicast, and Asynchronous messages
- **Mode Switch allows for use of an alternate PHY for unicast messages**
 - Signaling packet sent on base PHY
- **Allows for switch between FSK PHYs or FSK to OFDM**
 - Enables higher bandwidths for short amount of time for use cases like OTA
- **Supported on both FG25 (FSK and OFDM) and FG28 (FSK only)**
 - Exists natively as part of Silicon Labs Wi-SUN stack

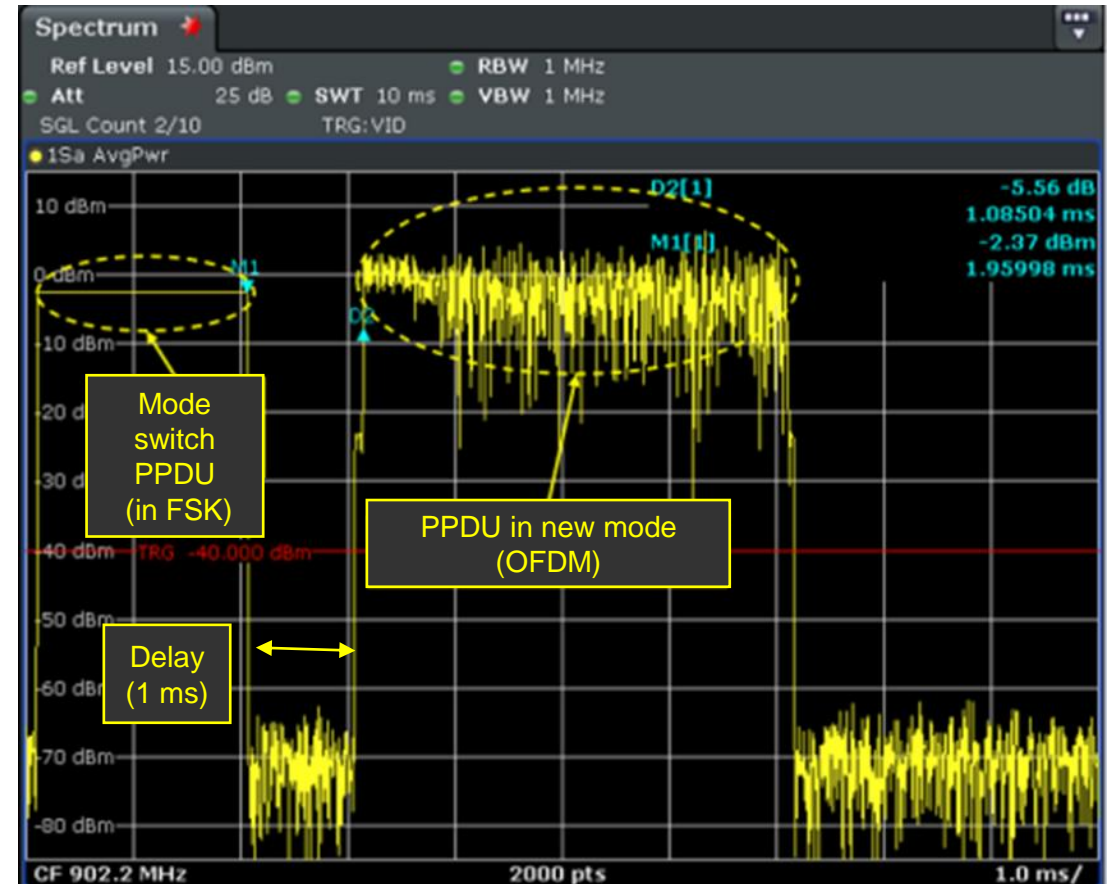
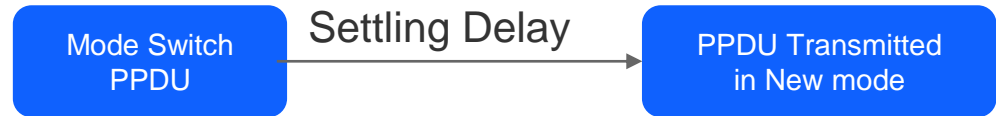

Mode Switch

- **Modulation and Data Rate (MDR) Switching**

- ▶ Introduced in FAN1.1

- **Goal**

- ▶ Temporarily switch from one MDR to another for one or more packets exchange
- ▶ Switching can be used to take advantage of the channel conditions or to meet application requirements

- **Silicon Labs Implementation**

- ▶ As per FAN1.1 spec
- ▶ Provides PHY Mode Switch and MAC Mode Switch APIs

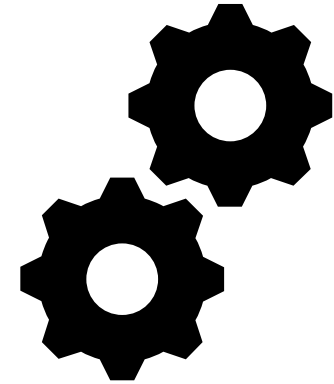

BENEFITS

- Best modulation and data rate for a specific channel condition
 - ▶ Reduced burst size, then power consumption
- Best modulation and data rate for a specific use-case
- If channel condition allows select higher data rate for cases like OTA [OFDM or FSK]
- Best modulation and data rate based on device capabilities
 - ▶ Devices advertise on the modes they support

DRAWBACKS

- Need to transmit a Mode Switch PPDU
- Can be slow due to long CCA (160 micro-Sec) and settling delay (0.5 to 1.5ms as per spec.)
- Reduced co-existence performance in technologies with short CCA
 - ▶ For example, 802.11ah (40 micro-second)

Concurrent Detection

- **Concurrent detection of two different PHYs**
 - The device listens to both FSK and OFDM at the same time
 - The first incoming signal triggers reception, the other one is aborted
 - Behaves like mode switch, without the need for the signaling packet (Mode Switch PPDU)
 - Concurrent Mode can be considered as a super Mode Switch
- **Silicon Labs Implementation**
 - Supported on FG25 [FSK & OFDM]
 - Currently available concurrent detection PHY pairs:
 - OFDM_option1_FSK_50kbps_NA
 - OFDM_option3_FSK_100kbps_JP
 - OFDM_option4_FSK_50kbps_EU

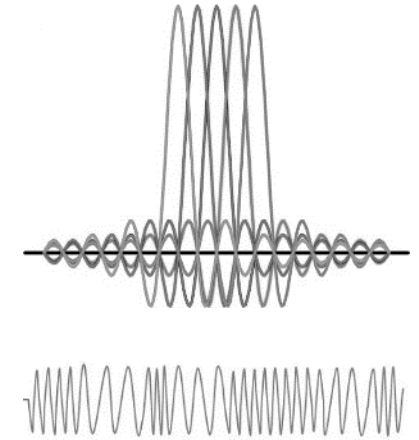

BENEFITS

- Faster than Mode Switch
 - No additional signaling and settling time
- Better co-existence performance than Mode Switch
 - Mode Switch performance can degrade in the presence of technologies with faster CCA, for example 802.11ah
- Increase throughputs without the overhead of a signaling packet
- Allows hybrid networks
 - FSK for robustness and legacy, OFDM for high bit rates

DRAWBACKS

- Only one payload can be received at a given time
 - It is not a dual reception
- Limited to single FSK and OFDM PHY concurrently
 - Detection of 2 FSK or 2 OFDM is not possible
- Need pre-defined PHY pairs
 - Additional pairs can be implemented based on customer needs

Concurrent Detection is not specified in Wi-SUN, but a capability of EFR32FG25

FAN 1.1 Coexistence with FAN 1.0

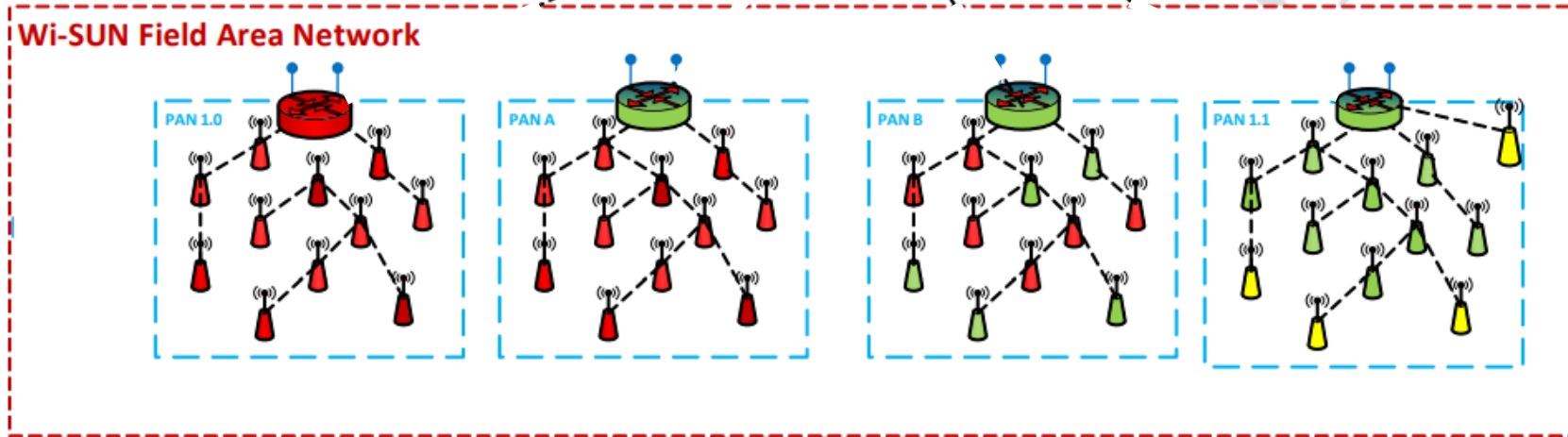

- **A FAN 1.0 Border Router locks the PAN to FAN 1.0**
 - Potential FAN 1.1 Routers would behave as FAN 1.0 routers
- **FAN 1.0 and FAN 1.1 coexistence in a PAN require that**
 - The Border Router is FAN 1.1
 - There is no LFN in the PAN
- **A PAN including LFN must be 100% FAN 1.1 (does not allow FAN 1.0 routers)**

- **Migration path from FAN 1.0 to LFN support**
 - Upgrade the Border Router to FAN 1.1
 - Upgrade all Routers to FAN 1.1
 - And enable LFN parenting
 - Configure the Border Router to
 - disable FAN 1.0 nodes support and
 - enable LFN support
 - Add LFNs
 - An LFN can connect only to routers with "LFN parenting" capability

Series 2 Proprietary Portfolio

	FG22	FG23	FGM230S	FG25	FG28
MCU/Clock	Cortex®-M33 / 38.4 MHz	Cortex®-M33 / 78 MHz	Cortex®-M33 / 39 MHz	Cortex®-M33 / 97.5 MHz	Cortex®-M33 / 78 MHz
Max Flash	512 kB	512 kB	512 kB	1920 kB	1024 kB
RAM	32 kB	64 kB	64 kB	512 kB	256 kB
Max GPIO	26	31	34	37	49
Active current	26 µA/MHz	26 µA/MHz	26 µA/MHz	30 µA/MHz	33 µA/MHz
EM2 current	1.2 uA (8 kb ret)	1.2 uA (16 kb ret)/1.5 uA (64 kb ret)	1.5 µA (64 kB ret)	2.6 uA (32 kb ret) /4.6 uA (512 kb ret)	2.8 uA (256 kb ret) /1.3 uA (16 kb ret)
TX Current	4.1 mA @ 0 dBm	25 mA @ 14 dBm	30 mA @ 14 dBm	58.6 mA @ 13 dBm	26.2 mA @ 14 dBm
RX Current	3.6 mA at 1 Mbps, GFSK	5.1 mA at 2 Mbps, GFSK	4.1 mA at 100 kbps, GFSK	6.3 mA at 400 kbps, GFSK	6.1 mA at 2 Mbps, GFSK
USART / LEUART / EUSART	2x USART	1x USART, 3x EUSART	3x EUSART	5x EUSART	1xUSART, 3xEUSART
Max Tx Power	+6 dBm	+20 dBm	+14 dBm	+16 dBm	+20 dBm
Max RX Sensitivity	-102.3	-125.8	-110	-125.8	-125.8
Security	Secure Vault-Mid + TrustZone	Secure Vault –Mid Secure Vault-High	Secure Vault –Mid Secure Vault-High	Secure Vault –Mid Secure Vault-High	Secure Vault –Mid Secure Vault-High
Other Features	ADC, Timers, RTC, Temp sensors, PRS	KEYSCAN,VDAC, LESENSE Timers, RTC, PCNT, ACMP Comparators, Temp sensors, VDAC, IADC, PRS	ADC, Timers, RTC, KEYSCAN,VDAC, ACMP LESENSE, PRS, Temp sensors	VDAC, LESENSE, Timers, RTC, Comparators, Temp sensors, ACM, IADC, PRS, PCNT	IADC,ACMP,VDAC, Temp sensors, LESENSE, Timers, RTC, PRS, PCNT, KEYSCAN, LCD, Temp sensors
Packages	QFN 40, QFN 32	QFN 40, QFN 48	SIP	QFN 56	QFN68, QFN48
Operating Temperature	-40 °C to 85 °C	-40 °C to +125 °C	-40 °C to 85 °C	-40 °C to +125 °C	-40 °C to +125 °C

Supported Protocols and Modulations

		FG22	FG23	FG25	FG28
Supported Protocols	Amazon Sidewalk		✓ (FSK Only)		✓ (Bluetooth LE and FSK)
	Wi-SUN		✓ (RCP Roadmap)	✓	✓
	Proprietary	✓	✓	✓	✓
	Bluetooth	✓			✓
	Wirepas		✓		
Supported Modulations	SUN-OFDM			✓	
	SUN-OQPSK			✓	
	SUN-FSK / 2/4(G)FSK	✓	✓	✓	✓
	(G)MSK	✓	✓	✓	✓
	(DSSS)-OQPSK	✓	✓	✓	✓
	OOK		✓		✓

Simplified Developer Experience

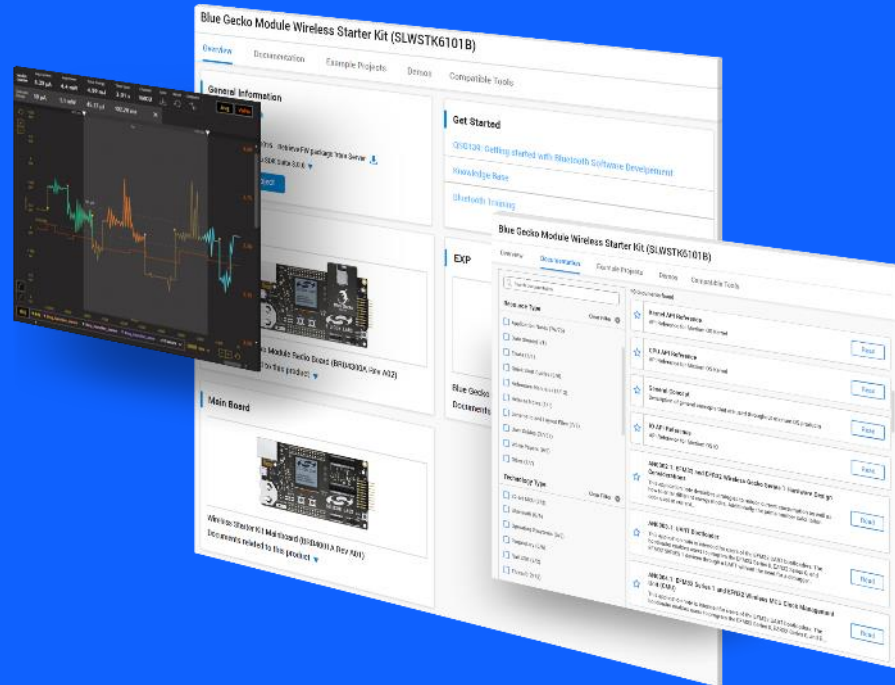

14
Simplicity
Silicon
2019.09B
Studio 5

Simplicity Studio 5

- **Interface**
 - ▶ Fresh, new & simplified
 - ▶ Intuitive out-of-the-box experience
 - ▶ Fast access to developer resources
 - ▶ Linux, Mac & Windows
- **Tools**
 - ▶ Configuration utilities
 - ▶ Compiler
 - ▶ Error & validation
 - ▶ IDE & command line support
 - ▶ Graphical hardware configurator
 - ▶ Energy Profiler – visual energy analysis
 - ▶ Network Analyzer – packet capture & decode

Radio Configurator

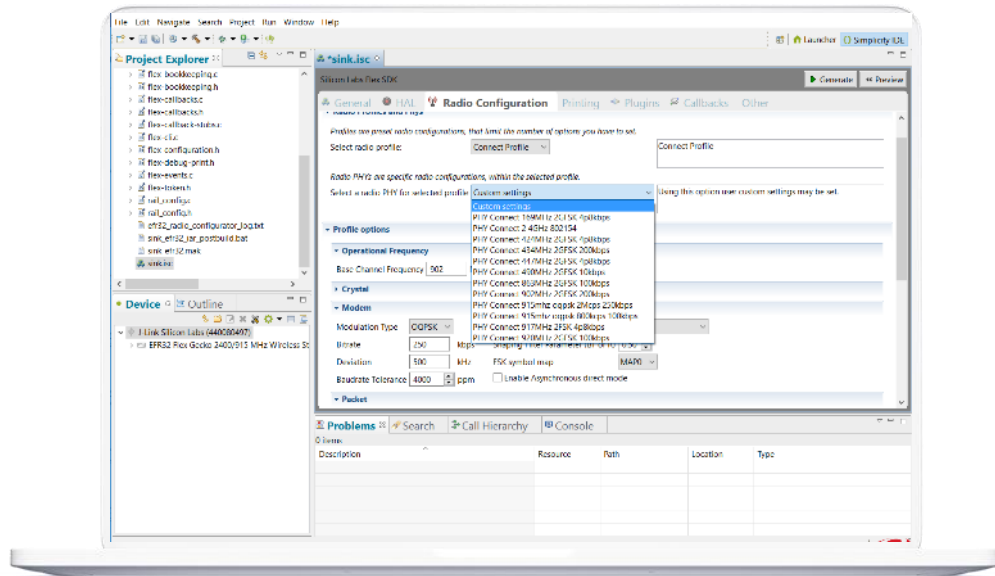

Tool to configure and optimize radio performance

Rapid Radio configuration and prototyping

- Predefined PHY settings for most common world regions
- Ability to create custom PHY settings for proprietary wireless applications

Intuitive GUI to configure PHY parameters

- Frequency bands, channel spacing, modulation
- Bit rate, symbol maps, symbol coding, filtering
- Timing detection, AFC, AGC and many others

Quick learning curve for new radio engineers

- Human readable configurations
- No need to learn specific radio registers and other IC internal information

Proprietary Development Hardware Options

	Explorer Kit	Dev Kit	Pro Kit
Debug Speed	1.6MHz	1.6MHz	8MHz
Debug USB	Full Speed	Full Speed	High Speed
Packet Trace Interface (PTI)	✓	✓	✓ 2x
Breakout Pads	✓	✓	✓
Pushbuttons & User LEDs	✓	✓	✓
Virtual COM	✓	✓	✓
Coin cell battery holder	-	✓	✓
On-board Sensors	-	✓	✓
Battery Pack Connector	-	✓	✓
Radio Board Connectors	-	-	✓
EXP Connector	-	-	✓
Display	-	-	✓
Debug OUT	-	-	EFM8/32, EFR32, EZR32
Debug Ethernet	-	-	100 Mbit/s
Energy Monitor (AEM)	-	-	✓
3 rd Party Hardware addons	✓	-	-

✓ Supported

✓ Optional or not mounted

- Not Supported



Explorer Kit	Dev Kit	Pro Kit
--------------	---------	---------

- Lowest price point
- On-board debugger and signal breakouts
- Minimal on-board features
- 3rd party hardware support

- Single device development board
- On-board debugger and signal breakouts
- On-board sensors
- Impressive out-of-the-box demos

- Modular development platform
- Advanced development use cases
- Energy profiling and external device debug
- Ethernet for large network test
- Designed to maximize reuse of EFR32 devices

Getting Started with FG25 Development: End Nodes & Border Routers



EFR32FG25 and Wi-SUN Pro Kits

Kit Contents

Wi-SUN Pro Kits

3x BRD4002A WSTK main boards
3x FG25 +16 dBm
3x BRD8016 Expansion board
3x Antenna

FG25 Pro Kits

1x BRD4002A WSTK main boards
1x FG25 +16 dBm
1x BRD8016 Expansion board
1x Antenna

Wi-SUN-PK6015A – 863-870 MHz + 16 dBm
Wi-SUN-PK6016A – 902-928 MHz + 16 dBm

FG25-PK6012A – 863-870 MHz +16 dBm
FG25-PK6011A – 902-928 MHz + 16 dBm

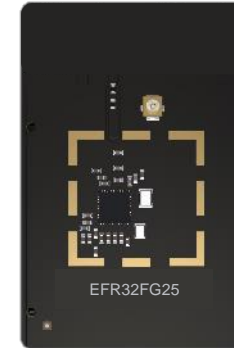

Available Radio Boards

FG25-RB4272A – 470MHz +16 dBm
FG25-RB4271A – 868MHz +16 dBm
FG25-RB4270B – 915MHz +16 dBm

Pro kit can be used for the development of End Nodes and Border Routers

Getting Started with FG28

▪ Pro Kit

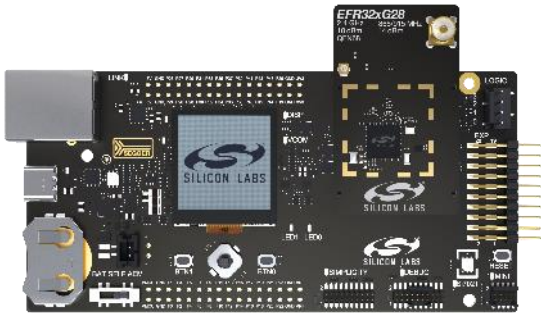

FG28-PK6024A (+14 dBm)
FG28-PK6025A (+20 dBm)

Kit Contents:

- 1x BRD4002A Mainboard
- 1x FG28-RB440xB 868 and 915MHz Radio Board
- 1x 868 / 915 MHz antenna
- 1x Flat Cable
- 1x 2xAA Battery Holder

▪ Explorer Kit



xG28-EK2705A

Kit Contents:

- 1x BRD2705A Explorer Kit Board
- 1x USB Type C

▪ Radio Boards



xG28-RB4400C (+14 dBm)
xG28-RB4401C (+20 dBm)

Kit Contents:

- 1x xG28-RB440xC 868 and 915MHz Radio Board
- 1x SMA Antenna connector

FAN 1.1 Certification

- FAN 1.1 Certification is coming

FAN 1.0

To be stopped once FAN 1.0+/
FAN 1.1 core is ready

PHY 1.0
(1V08)

PHY1.1 (2v02)	
PHY Mode Switch	O
FSK	M*
OFDM	O

FAN 1.0+ = FAN 1.1 Core	BR	R	LFN
PAN-wide IE	M	M	-
MAC-Command Mode Switch	O	O	-
PHY Mode Switch	O	O	-
LFN Parenting	-	-	-
LFN features	-	-	-
FSK	M*	M*	-
OFDM	-	-	-

FAN 1.1 Core + HP	BR	R	LFN
PAN-wide IE	M	M	-
MAC-Command Mode Switch	O	O	-
PHY Mode Switch	M	M	-
LFN Parenting	-	-	-
LFN features	-	-	-
FSK	M*	M*	-
OFDM	M*	M*	-

FAN 1.1 Core + LE	BR	R	LFN
PAN-wide IE	M	M	O
MAC-Command Mode Switch	O	O	O
PHY Mode Switch	O	O	O
LFN Parenting	M	M	-
LFN features	-	-	M
FSK	M*	M*	M*
OFDM	O	O	O

2019

2023

2024 H1

2024 H2

Certification of Silicon Labs products

- FAN 1.0 certified products

FAN 1.0		
	EFR32FG12	EFR32MG12
Border Router	WSA285	WSA286
Router	WSA265	WSA266
PHY: 800MHz 900MHz	WSA291 WSA258	WSA292 WSA259

- Find WSA certificates at: <https://wi-sun.org/certified-products-list/>

- FAN 1.1 certifications plan

FAN 1.1			
	EFR32FG25		EFR32FG28
	HP	LE	LE
Border Router	On-going (CTBU)		2024*
Router			2024*
LFN			2024*
PHY: 800MHz 900MHz			Yes (CTBU) WSA345 WSA335

- CTBU:** Certification Test Bed Unit - EFR32FG25 is part of the certification test beds (PHY and FAN)
- 2024*: pending certification Test bed completion

Thank You

Watch  **ON DEMAND**

2024

tech **talks**

BY  SILICON LABS

APAC Tech Talks: Wireless Technology Training



Register Now



MATTER



BLUETOOTH



WI-FI



LPWAN



WIRELESS COMPUTE



SILICON LABS