

BGM220PC22 Module Radio Board BRD4311A Reference Manual



The BRD4311A Wireless Gecko Radio Board contains a Wireless Gecko module, which integrates Silicon Labs' EFR32BG22 Wireless Gecko SoC into a small form factor module. The fully certified module contains all components (a high-performance transceiver, an energy efficient 32-bit MCU, crystals, RF passives, and antenna) required for a system-level implementation of Bluetooth® Low Energy wireless networks operating in the 2.4 GHz band with 8 dBm output power.

The BRD4311A Wireless Gecko Radio Board plugs into the Wireless Starter Kit Mainboard, which is included with the Wireless Gecko Starter Kit and gives access to display, buttons, and additional features from expansion boards. With the supporting Simplicity Studio suite of tools, developers can take advantage of graphical wireless application development, BGScript for Python-like scripting, and visual energy profiling and optimization.

This document contains a brief introduction and description of the BRD4311A Radio Board features, focusing on the RF performance.

RADIO BOARD FEATURES

- Wireless Module: BGM220PC22HNA2
 - CPU core: ARM Cortex®-M33
 - Flash memory: 512 kB
 - RAM: 32 kB
 - Operation frequency: 2.4 GHz
 - Transmit power: 8 dBm
 - Integrated chip antenna, RF matching network, crystals, and decoupling
- 8 Mbit low-power serial flash for over-the-air updates



Table of Contents

1. Introduction	3
2. Radio Board Connector	4
2.1 Introduction	4
2.2 Radio Board Connector Pin Associations	4
3. Radio Board Block Summary	5
3.1 Introduction	5
3.2 Radio Board Block Diagram	5
3.3 Radio Board Block Description	5
3.3.1 Wireless Module	5
3.3.2 Radio Board Connectors	5
3.3.3 Serial Flash	6
3.3.4 Serial EEPROM	6
4. Mechanical Details	7
5. EMC Compliance	8
5.1 Introduction	8
5.2 EMC Regulations for 2.4 GHz	8
5.2.1 ETSI EN 300-328 Emission Limits for the 2400-2483.5 MHz Band	8
5.2.2 FCC15.247 Emission Limits for the 2400-2483.5 MHz Band	8
5.2.3 Applied Emission Limits for the 2.4 GHz Band	8
6. RF Performance	9
6.1 Radiated Power Measurements	9
6.1.1 Radiated Measurements in the 2.4 GHz Band	9
6.1.2 Antenna Pattern Measurements	10
7. EMC Compliance Recommendations	11
7.1 Recommendations for 2.4 GHz ETSI EN 300-328 Compliance	11
7.2 Recommendations for 2.4 GHz FCC 15.247 Compliance	11
8. Board Revision History	12
9. Errata	13
10. Document Revision History	14

1. Introduction

The BRD4311A Radio Boards provide a development platform (together with the Wireless Starter Kit Mainboard) for the Silicon Labs Wireless Gecko modules.

By carrying the BGM220PC22 module, the BRD4311A Radio Board is designed to operate in the 2400-2483.5 MHz with the maximum of 8 dBm output power.

To develop and/or evaluate the BGM220PC22 module, the BRD4311A Radio Board can be connected to the Wireless Starter Kit Mainboard to get access to display, buttons, and additional features from expansion boards (EXP boards).

2. Radio Board Connector

2.1 Introduction

The board-to-board connector scheme allows access to all BGM220PC22 GPIO pins as well as the RESETn signal. For more information on the functions of the available pins, see the BGM220PC22 data sheet.

2.2 Radio Board Connector Pin Associations

The figure below shows the mapping between the connector and the BGM220PC22 pins and their function on the Wireless Starter Kit Mainboard.

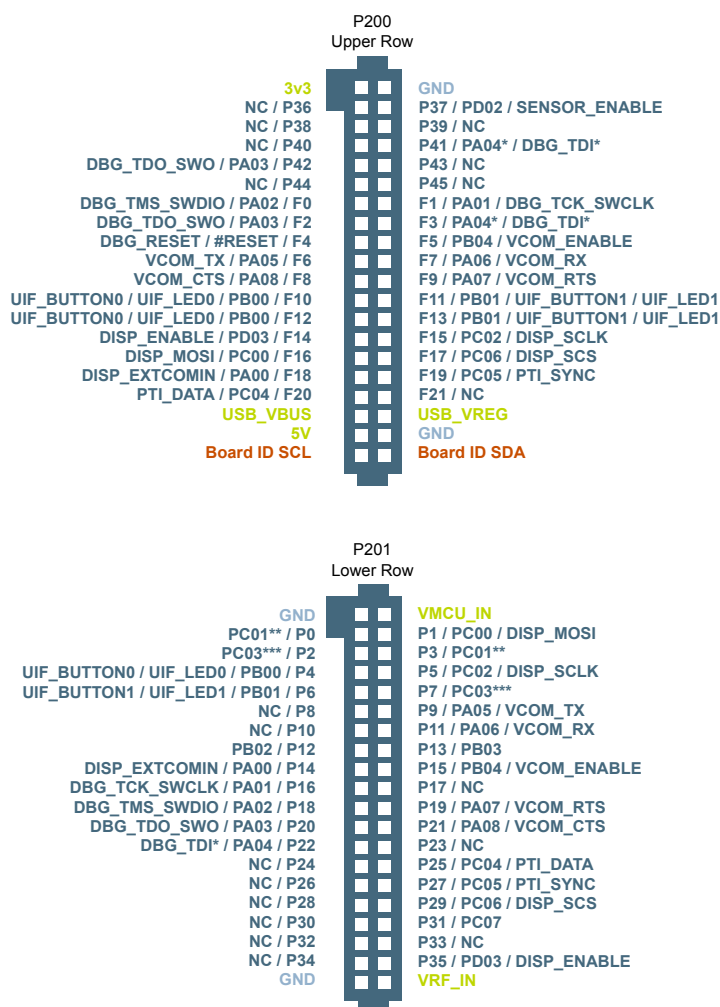

* Optional 0R resistor should be mounted to enable this connection. (Mutually exclusive with FLASH_SCS.)

** Mutually exclusive connection. Default: PC01 to P3.

*** Mutually exclusive connection. Default: PC03 to P7.

Figure 2.1. BRD4311A Radio Board Connector Pin Mapping

3. Radio Board Block Summary

3.1 Introduction

This section introduces the blocks of the BRD4311A Radio Board.

3.2 Radio Board Block Diagram

The block diagram of the BRD4311A Radio Board is shown in the figure below.

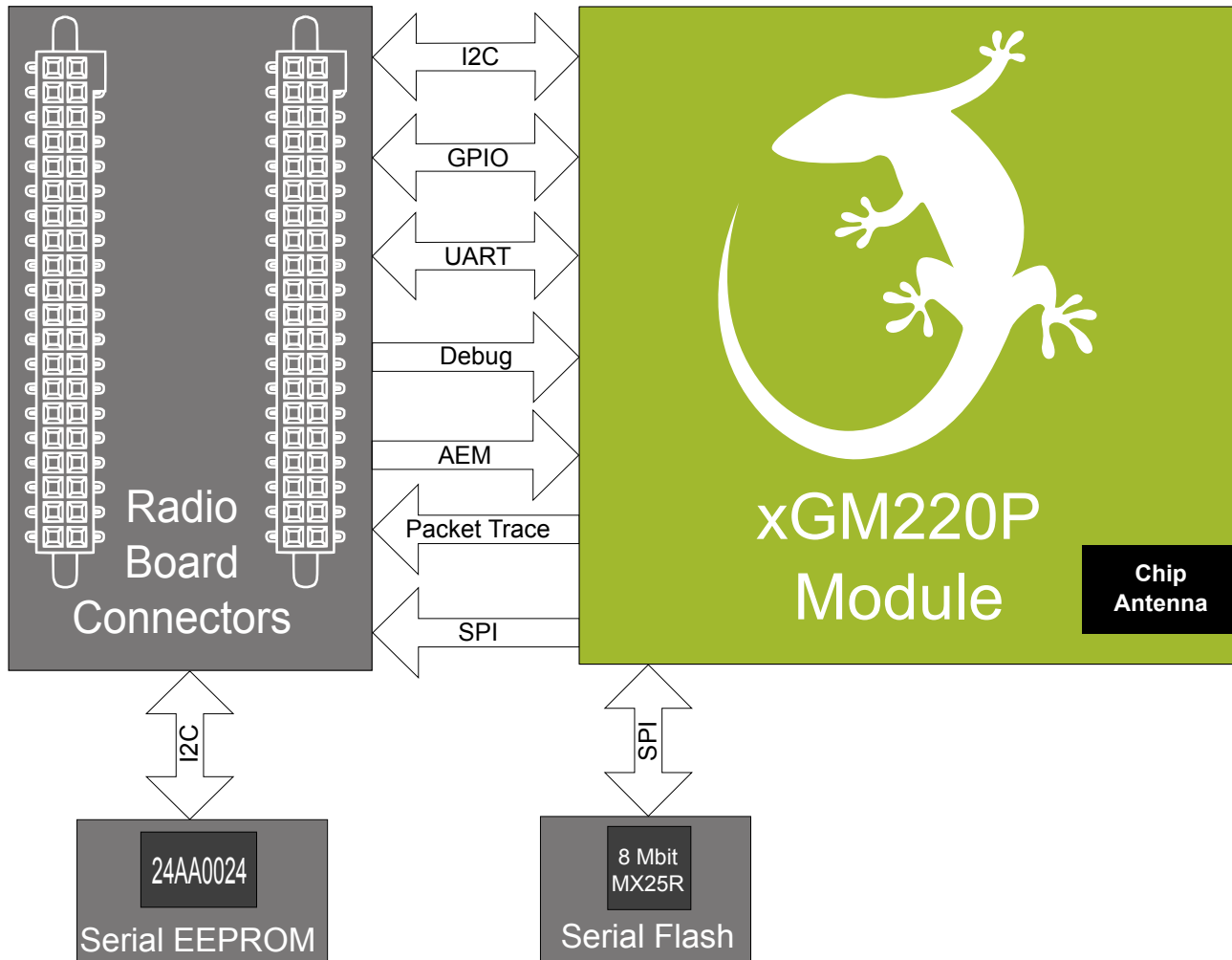

Figure 3.1. BRD4311A Block Diagram

3.3 Radio Board Block Description

3.3.1 Wireless Module

The BGM220PC22HNA2 module incorporated on the BRD4311A Wireless Gecko Radio Board features a 32-bit Cortex[®]-M33 core, 512 kB of flash memory, 32 kB of RAM, crystals, and a 2.4 GHz band transceiver with RF passives and integrated antenna output power up to 8 dBm. For additional information on the BGM220PC22HNA2, refer to the BGM220P data sheet.

3.3.2 Radio Board Connectors

Two dual-row, 0.05" pitch polarized connectors make up the BRD4311A Radio Board interface to the Wireless Starter Kit Mainboard.

For more information on the pin mapping between the BGM220PC22HNA2 and the Radio Board Connector, refer to section [2.2 Radio Board Connector Pin Associations](#).

3.3.3 Serial Flash

The BRD4311A Radio Board is equipped with an 8 Mbit Macronix MX25R SPI flash that is connected directly to the BGM220PC22 to support over-the-air (OTA) updates. For additional information on the pin mapping, see the BRD4311A schematic.

3.3.4 Serial EEPROM

The BRD4311A Radio Board is equipped with a serial I²C EEPROM for board identification and to store additional board-related information.

4. Mechanical Details

The BRD4311A Radio Board is illustrated in the figures below.

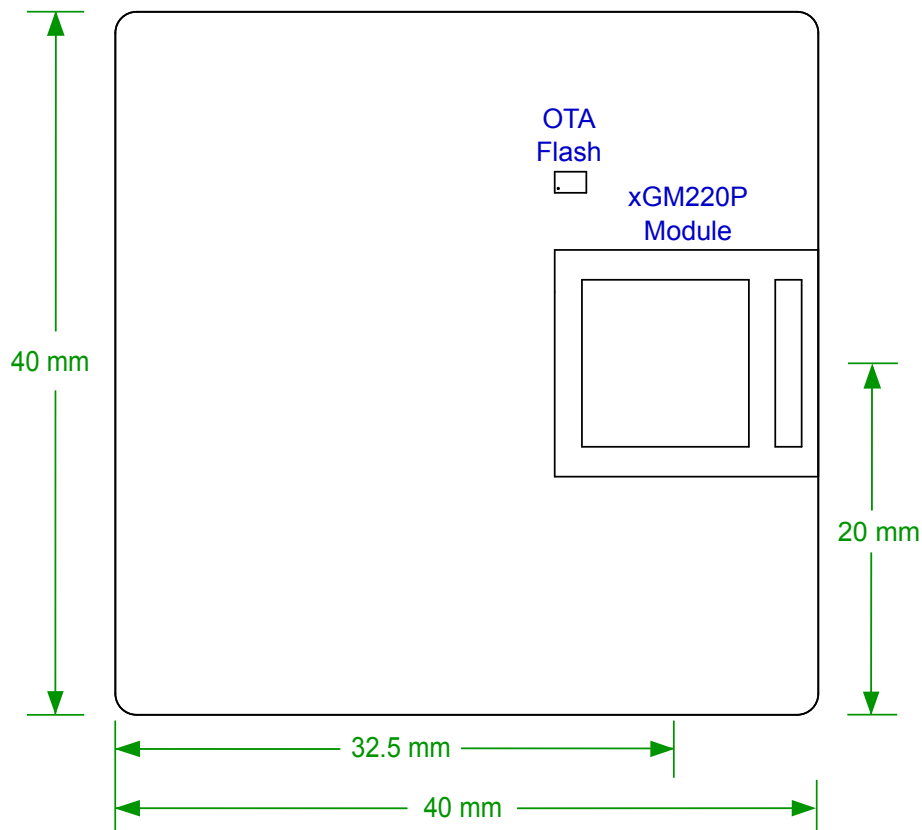

Figure 4.1. BRD4311A Top View

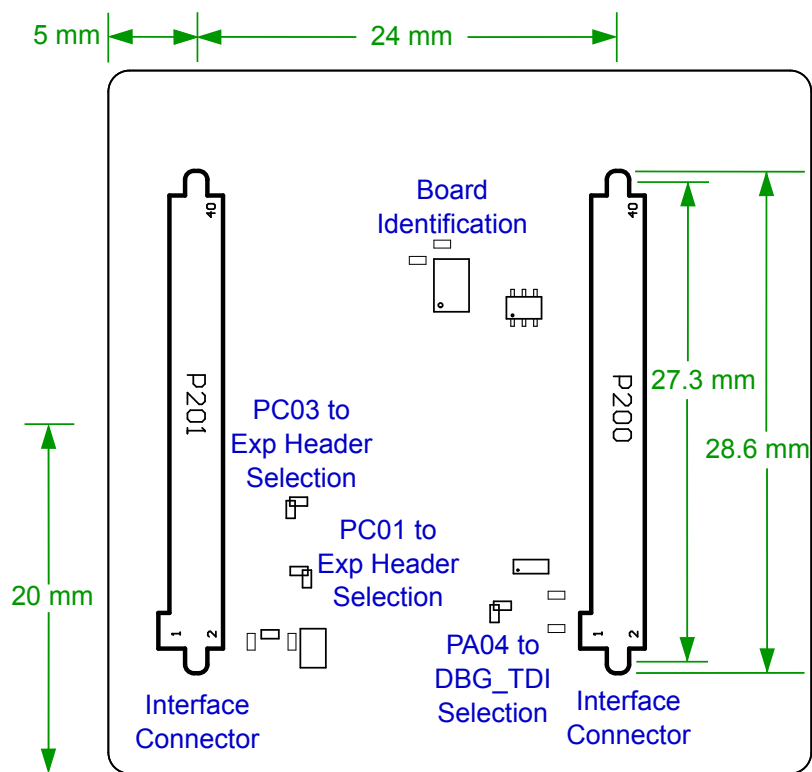

Figure 4.2. BRD4311A Bottom View

5. EMC Compliance

5.1 Introduction

Compliance of the fundamental and harmonic levels of the BRD4311A Radio Board is tested against the following standards:

- 2.4 GHz:
 - ETSI EN 300-328
 - FCC 15.247

5.2 EMC Regulations for 2.4 GHz

5.2.1 ETSI EN 300-328 Emission Limits for the 2400-2483.5 MHz Band

Based on ETSI EN 300-328, the allowed maximum fundamental power for the 2400-2483.5 MHz band is 20 dBm EIRP. For the unwanted emissions in the 1 GHz to 12.75 GHz domain, the specific limit is -30 dBm EIRP.

5.2.2 FCC15.247 Emission Limits for the 2400-2483.5 MHz Band

FCC 15.247 allows conducted output power up to 1 W (30 dBm) in the 2400-2483.5 MHz band. For spurious emissions, the limit is -20 dBc based on either conducted or radiated measurement, if the emission is not in a restricted band. The restricted bands are specified in FCC 15.205. In these bands, the spurious emission levels must meet the levels set out in FCC 15.209. In the range from 960 MHz to the frequency of the 5th harmonic, it is defined as 0.5 mV/m at 3 m distance which equals to -41.2 dBm in EIRP.

If operating in the 2400-2483.5 MHz band, the 2nd, 3rd, and 5th harmonics can fall into restricted bands. As a result, for those harmonics the -41.2 dBm limit should be applied. For the 4th harmonic the -20 dBc limit should be applied.

5.2.3 Applied Emission Limits for the 2.4 GHz Band

The above ETSI limits are applied both for conducted and radiated measurements.

The FCC restricted band limits are radiated limits only. In addition, Silicon Labs applies the same restrictions to the conducted spectrum. By doing so, compliance with the radiated limits can be estimated based on the conducted measurement, by assuming the use of an antenna with 0 dB gain at the fundamental and the harmonic frequencies.

The overall applied limits are shown in the table below. For the harmonics that fall into the FCC restricted bands, the FCC 15.209 limit is applied. ETSI EN 300-328 limit is applied for the rest.

Table 5.1. Applied Limits for Spurious Emissions for the 2.4 GHz Band

Harmonic	Frequency	Limit
2nd	4800~4967 MHz	-41.2 dBm
3rd	7200~7450.5 MHz	-41.2 dBm
4th	9600~9934 MHz	-30.0 dBm
5th	12000~12417.5 MHz	-41.2 dBm

6. RF Performance

6.1 Radiated Power Measurements

During measurements, the BRD4311A Radio Board was attached to a Wireless Starter Kit Mainboard which was supplied by USB. The voltage supply for the Radio Board was 3.3 V. The radiated power was measured in an antenna chamber by rotating the board 360 degrees with horizontal and vertical reference antenna polarizations in the XY, XZ, and YZ cuts. The measurement planes are illustrated in the figure below.

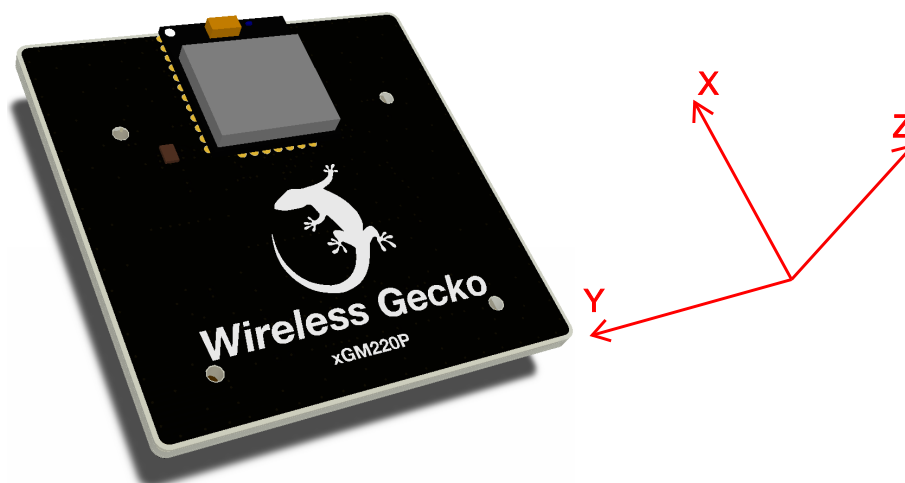

Figure 6.1. Illustration of Reference Planes with a Radio Board Plugged into the Wireless Starter Kit Mainboard

Note: The radiated measurement results presented in this document were recorded in an unlicensed antenna chamber. Also, the radiated power levels may change depending on the actual application (PCB size, used antenna, and so on). Therefore, the absolute levels and margins of the final application are recommended to be verified in a licensed EMC testhouse.

6.1.1 Radiated Measurements in the 2.4 GHz Band

The supply for the module (VDD) was 3.3 V provided by the mainboard; for details, see the BRD4311A schematic. The transceiver was operated in continuous carrier transmission mode. The output power of the radio was set to 8 dBm.

The fundamental was set to the frequency where the maximum antenna gain was measured. The results are shown in the table below.

Note: The frequency in which the antenna gain has its maximum value can vary between modules due to the technological spreading of the passive RF components and the antenna.

Table 6.1. Maximums of the Measured Radiated Powers in EIRP [dBm]

Frequency (2440 MHz)	EIRP [dBm]	Orientation	Margin [dB]	Limit in EIRP [dBm]
Fund	8.3	XY/H	21.7	30.0
2nd	<-50*	-/-	>10	-41.2
3rd	-45.1	XZ/H	3.9	-41.2
4th	<-50*	-/-	>20	-30.0
5th	<-50*	-/-	>10	-41.2

* Signal level is below the Spectrum Analyzer noise floor.

As shown in the table above, due to the antenna gain, the fundamental is slightly higher than 8 dBm. Only the 3rd harmonic is above the Spectrum Analyzer noise level, but it is still under the -41.2 dBm applied limit.

Depending on the applied modulation scheme, the measured power levels are usually lower compared to the results with unmodulated carrier. As a result, the above margins will be improved if modulated transmission is used.

6.1.2 Antenna Pattern Measurements

The measured normalized antenna patterns are shown in the following figures.

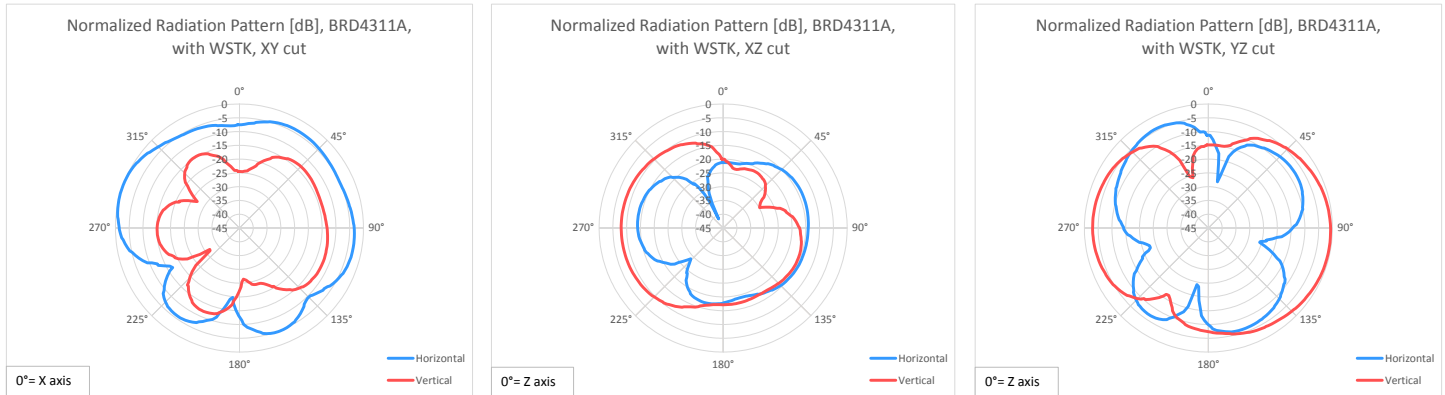

Figure 6.2. Normalized Antenna Pattern of the BRD4311A with the Wireless Starter Kit Mainboard

7. EMC Compliance Recommendations

7.1 Recommendations for 2.4 GHz ETSI EN 300-328 Compliance

As shown in section 6. [RF Performance](#), the power of the fundamental frequency of the BRD4311A Wireless Gecko Radio Board with 8 dBm output is compliant with the 20 dBm limit of the ETSI EN 300-328 regulation. The harmonic emissions are under the -30 dBm limit with large margin.

7.2 Recommendations for 2.4 GHz FCC 15.247 Compliance

As shown in section 6. [RF Performance](#), the power of the fundamental frequency of the BRD4311A Wireless Gecko Radio Board with 8 dBm output is compliant with the 30 dBm limit of the FCC 15.247 regulation. The harmonic emissions are under the applied limits.

8. Board Revision History

The board revision is laser engraved in the Board Info field on the bottom side of the PCB, as outlined in the figure below. The revision printed on the silkscreen is the PCB revision.

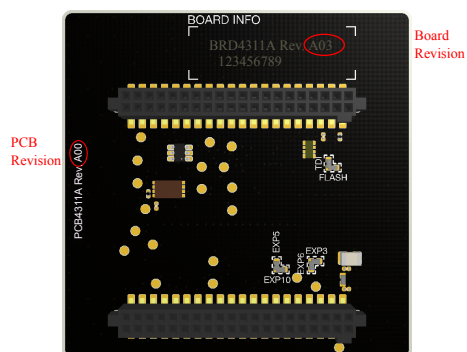

Figure 8.1. Revision Info

Table 8.1. BRD4311A Radio Board Revision History

Board Revision	Description
A03	Updated U1 OPN.
A02	Dummy revision update for modules with updated LFXO.
A01	Updated module OPN.
A00	Initial production release.

9. Errata

There are no known errata at present.

10. Document Revision History

Revision 1.0

May, 2020

- Initial document release.

Silicon Labs

Simplicity Studio™4



Simplicity Studio

One-click access to MCU and wireless tools, documentation, software, source code libraries & more. Available for Windows, Mac and Linux!



IoT Portfolio
www.silabs.com/IoT



SW/HW
www.silabs.com/simplicity



Quality
www.silabs.com/quality



Support and Community
community.silabs.com

Disclaimer

Silicon Labs intends to provide customers with the latest, accurate, and in-depth documentation of all peripherals and modules available for system and software implementers using or intending to use the Silicon Labs products. Characterization data, available modules and peripherals, memory sizes and memory addresses refer to each specific device, and "Typical" parameters provided can and do vary in different applications. Application examples described herein are for illustrative purposes only. Silicon Labs reserves the right to make changes without further notice to the product information, specifications, and descriptions herein, and does not give warranties as to the accuracy or completeness of the included information. Without prior notification, Silicon Labs may update product firmware during the manufacturing process for security or reliability reasons. Such changes will not alter the specifications or the performance of the product. Silicon Labs shall have no liability for the consequences of use of the information supplied in this document. This document does not imply or expressly grant any license to design or fabricate any integrated circuits. The products are not designed or authorized to be used within any FDA Class III devices, applications for which FDA premarket approval is required or Life Support Systems without the specific written consent of Silicon Labs. A "Life Support System" is any product or system intended to support or sustain life and/or health, which, if it fails, can be reasonably expected to result in significant personal injury or death. Silicon Labs products are not designed or authorized for military applications. Silicon Labs products shall under no circumstances be used in weapons of mass destruction including (but not limited to) nuclear, biological or chemical weapons, or missiles capable of delivering such weapons. Silicon Labs disclaims all express and implied warranties and shall not be responsible or liable for any injuries or damages related to use of a Silicon Labs product in such unauthorized applications.

Trademark Information

Silicon Laboratories Inc.®, Silicon Laboratories®, Silicon Labs®, SiLabs® and the Silicon Labs logo®, Bluegiga®, Bluegiga Logo®, ClockBuilder®, CMEMS®, DSPLL®, EFM®, EFM32®, EFR, Ember®, Energy Micro, Energy Micro logo and combinations thereof, "the world's most energy friendly microcontrollers", Ember®, EZLink®, EZRadio®, EZRadioPRO®, Gecko®, Gecko OS, Gecko OS Studio, ISOModem®, Precision32®, ProSLIC®, Simplicity Studio®, SiPHY®, Telegesis, the Telegesis Logo®, USBXpress®, Zentri, the Zentri logo and Zentri DMS, Z-Wave®, and others are trademarks or registered trademarks of Silicon Labs. ARM, CORTEX, Cortex-M3 and THUMB are trademarks or registered trademarks of ARM Holdings. Keil is a registered trademark of ARM Limited. Wi-Fi is a registered trademark of the Wi-Fi Alliance. All other products or brand names mentioned herein are trademarks of their respective holders.



Silicon Laboratories Inc.
400 West Cesar Chavez
Austin, TX 78701
USA

<http://www.silabs.com>